

## HIGH EFFICIENCY FAST RECOVERY RECTIFIER DIODES

- VERY LOW CONDUCTION LOSSES
- NEGLIGIBLE SWITCHING LOSSES
- LOW FORWARD AND REVERSE RECOVERY TIMES
- HIGH SURGE CURRENT AND AVALANCHE CAPABILITY
- THE SPECIFICATIONS AND CURVES ENABLE THE DETERMINATION OF  $t_{rr}$  AND  $I_{RM}$  AT 100°C UNDER USERS CONDITIONS

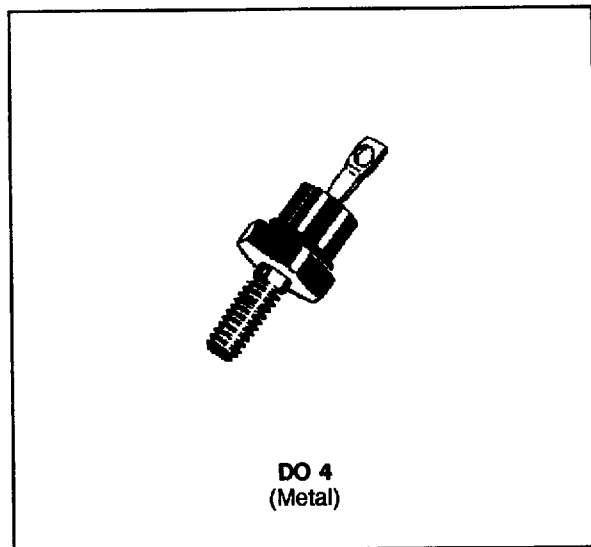

### DESCRIPTION

Low voltage drop rectifiers suited for switching mode power supply.

### ABSOLUTE MAXIMUM RATINGS (limiting values)

Symbol	Parameter		Value	Unit
$I_{FRM}$	Repetitive Peak Forward Current	$t_p \leq 20\mu s$	500	A
$I_F (RMS)$	RMS Forward Current		50	A
$I_F (AV)$	Average Forward Current	$T_C = 115^\circ C$ $\delta = 0.5$	25	A
$I_{FSM}$	Surge non Repetitive Forward Current	$t_p = 10ms$ Sinusoidal	500	A
$P_{tot}$	Power Dissipation	$T = 100^\circ C$	33	W
$T_{stg}$ $T_J$	Storage and Junction Temperature Range		- 40 to + 150 - 40 to + 150	$^\circ C$

Symbol	Parameter	BYT 77-				Unit
		50	100	150	200	
$V_{RRM}$	Repetitive Peak Reverse Voltage	50	100	150	200	V
$V_{RSM}$	Non Repetitive Peak Reverse Voltage	55	110	165	220	V

### THERMAL RESISTANCE

Symbol	Parameter	Value	Unit
$R_{th(j-c)}$	Junction-case	1.5	$^\circ C/W$

**ELECTRICAL CHARACTERISTICS**

**STATIC CHARACTERISTICS**

Symbol	Test Conditions		Min.	Typ.	Max.	Unit
I <sub>R</sub>	T <sub>J</sub> = 25°C	V <sub>R</sub> = V <sub>RRM</sub>			25	μA
	T <sub>J</sub> = 100°C				2.5	mA
V <sub>F</sub>	T <sub>J</sub> = 25°C	I <sub>F</sub> = 63A			1.1	V
	T <sub>J</sub> = 100°C	I <sub>F</sub> = 20A			0.85	

**RECOVERY CHARACTERISTICS**

Symbol				Min.	Typ.	Max.	Unit
t <sub>rr</sub>	T <sub>J</sub> = 25°C V <sub>R</sub> = 30V	I <sub>F</sub> = 1A see figure 12	di <sub>F</sub> /dt = - 50A/μs			50	ns
Q <sub>rr</sub>	T <sub>J</sub> = 25°C V <sub>R</sub> ≤ 30V	I <sub>F</sub> = 2A	di <sub>F</sub> /dt = - 20A/μs			20	nC
t <sub>fr</sub>	T <sub>J</sub> = 25°C Measured at 1.1 x V <sub>F</sub>	I <sub>F</sub> = 1A	t <sub>r</sub> = 5ns		10		ns
V <sub>FP</sub>	T <sub>J</sub> = 25°C	I <sub>F</sub> = 1A	t <sub>r</sub> = 5ns		1.5		V

To evaluate the conduction losses use the following equations:

$$V_F = 0.66 + 0.0047I_F \quad P = 0.66 \times I_{F(AV)} + 0.0047 I_{F(RMS)}^2$$

Figure 1. Power losses versus average current.

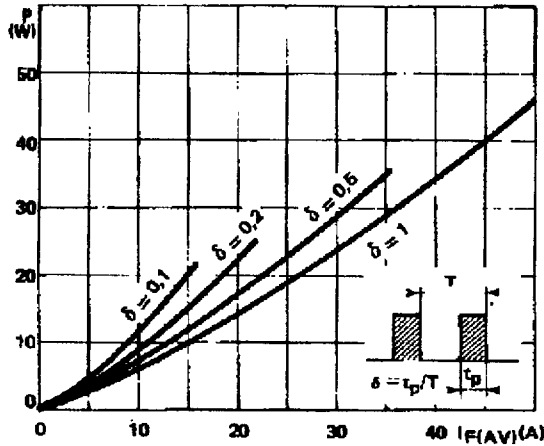

Figure 3. Non repetitive peak surge current versus duration

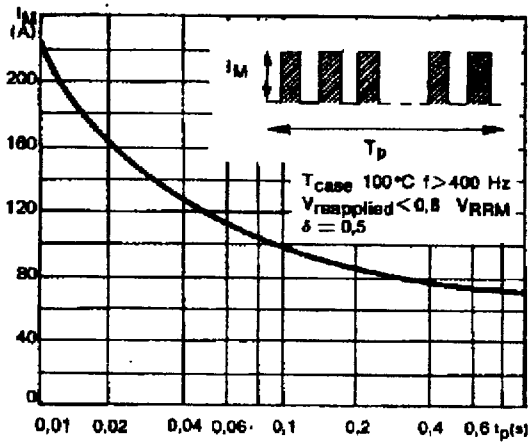

Figure 5. Voltage drop and dispersion versus forward current.

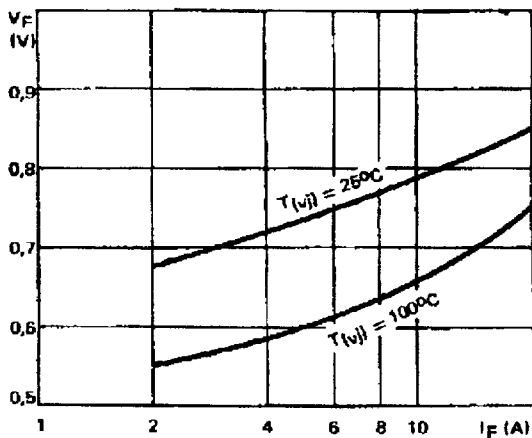

Figure 2. Peak current versus form factor.

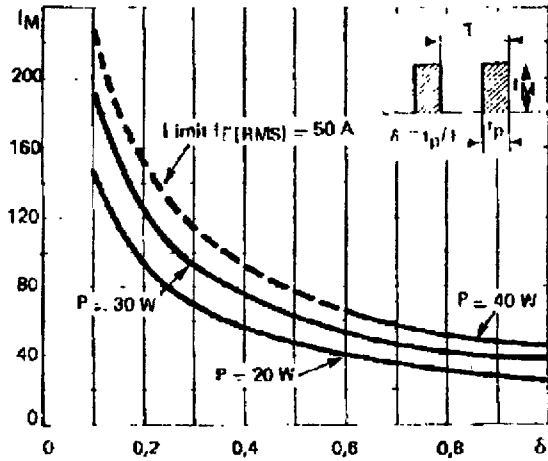

Figure 4. Thermal impedance versus pulse width.

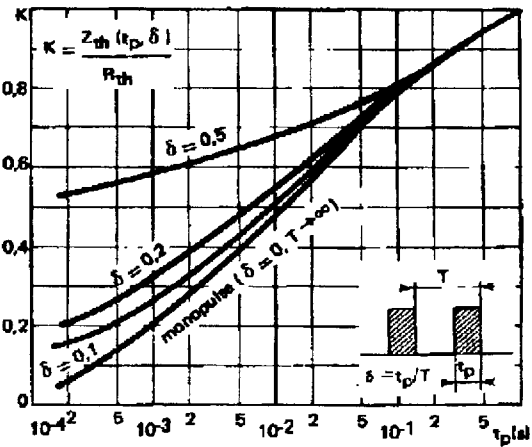

Figure 6. Recovery charge versus forward current.

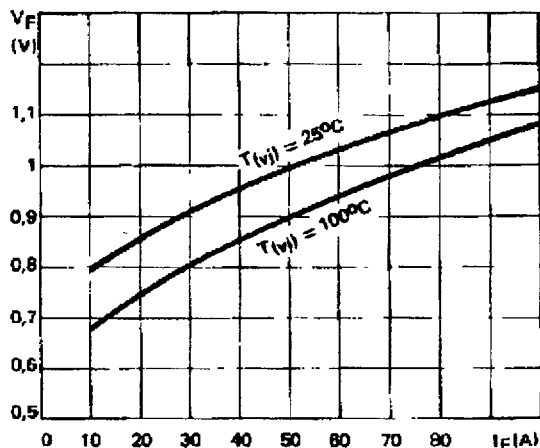

Figure 7. Capacitance versus reverse voltage applied

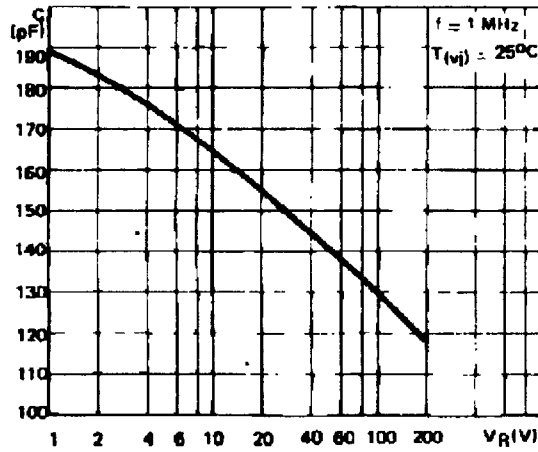

Figure 9. Recovery time versus di<sub>F</sub>/dt.

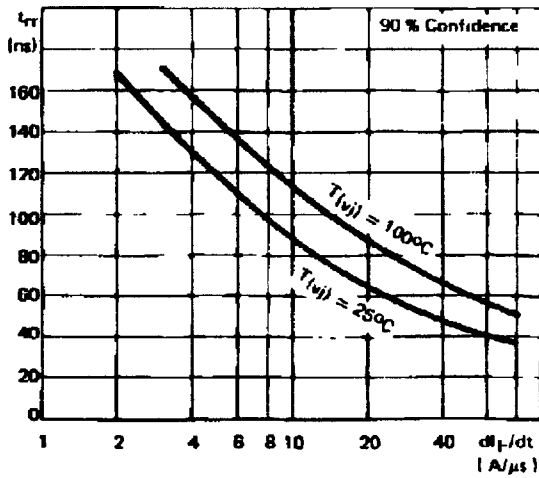

Figure 11. Dynamic parameter versus junction temperature

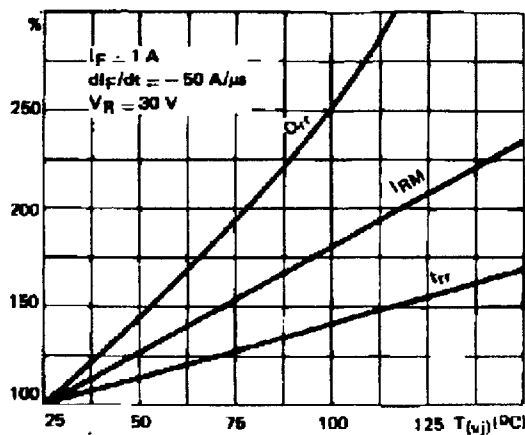

Figure 8. Recovery charge versus di<sub>F</sub>/dt

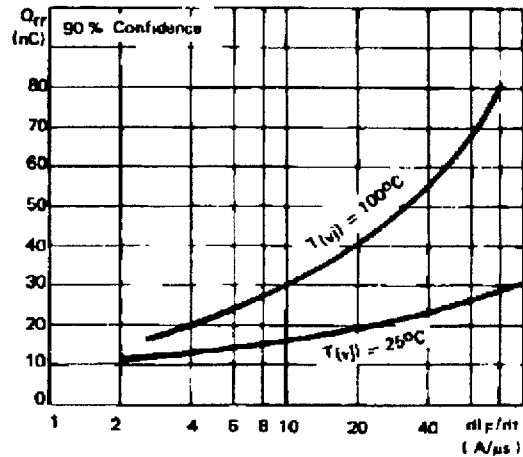

Figure 10. Peak reverse current versus di<sub>F</sub>/dt

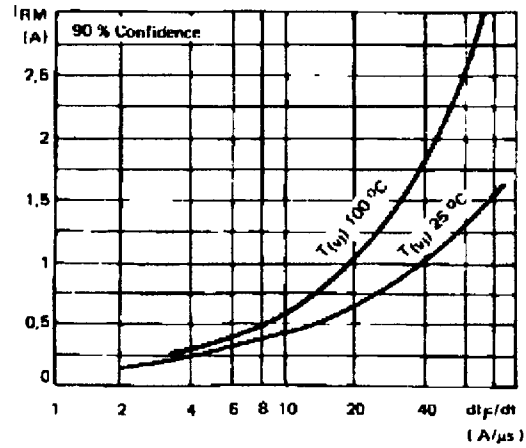
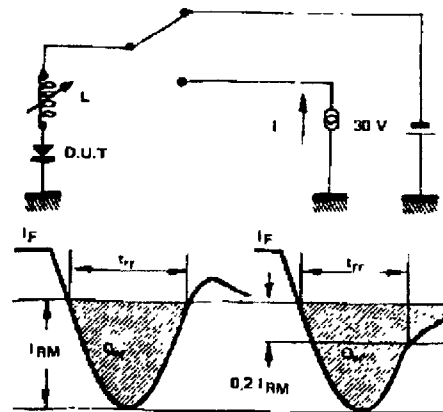
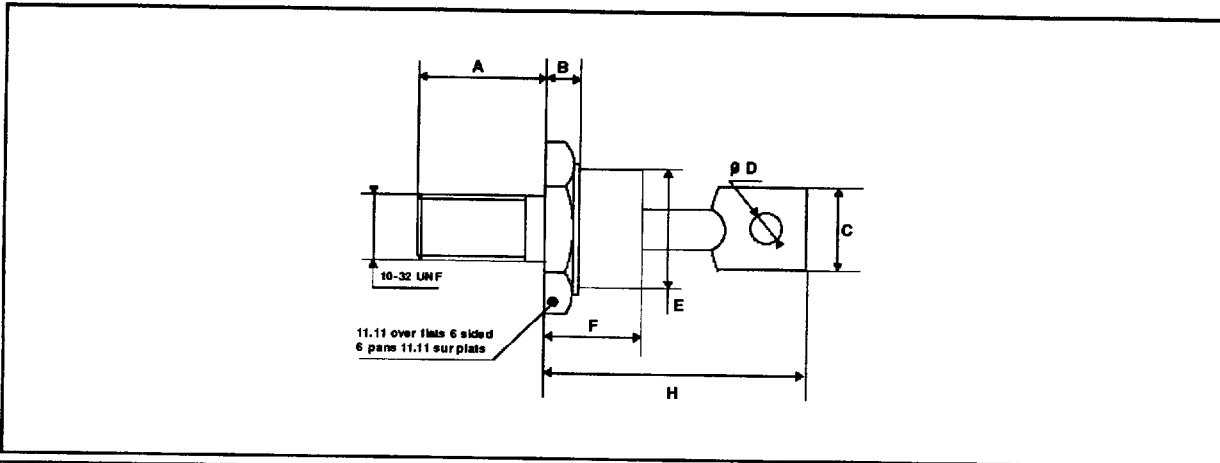

Figure 12. Measurement of t<sub>rr</sub> (fig. 9) and I<sub>RM</sub> (fig. 10)



**PACKAGE MECHANICAL DATA**

**DO 4 Metal**



REF.	DIMENSIONS					
	Millimeters			Inches		
	Min.	Typ.	Max.	Min.	Typ.	Max.
A	10.72		11.50	0.422		0.453
B	2.00		4.40	0.079		0.0173
C			6.35			0.25
D	1.53			0.060		
E			10.76			0.424
F			10.28			0.405
H			20.32			0.800

Cooling method: by conduction (method C)

Marking: Cathode connected to case: type number

Anode connected to case : type number + suffix R (Consult us for these reverse version datasheets)

Weight: 5.1g

Recommended torque value: 180cm. N

Maximum torque value: 220cm. N

Information furnished is believed to be accurate and reliable. However, SGS-THOMSON Microelectronics assumes no responsibility for the consequences of use of such information nor for any infringement of patents or other rights of third parties which may result from its use. No license is granted by implication or otherwise under any patent or patent rights of SGS-THOMSON Microelectronics. Specifications mentioned in this publication are subject to change without notice. This publication supersedes and replaces all information previously supplied. SGS-THOMSON Microelectronics products are not authorized for use as critical components in life support devices or systems without express written approval of SGS-THOMSON Microelectronics.

© 1994 SGS-THOMSON Microelectronics - Printed in Italy - All rights reserved.

SGS-THOMSON Microelectronics GROUP OF COMPANIES

Australia - Brazil - France - Germany - Hong Kong - Italy - Japan - Korea - Malaysia - Malta - Morocco - The Netherlands - Singapore - Spain - Sweden - Switzerland - Taiwan - United Kingdom - U.S.A.